

Serie HP6000 racores de latón super rápidos para aplicaciones de lubricación

Nuevo

Diámetros externos: 4, 6 mm ; Roscas: métrica M5, M6x0,75, M6x1, M8x1, M10x1, M10x1,5, M12x1, M14x1.
ISO7 (BSPT): R1/8, R1/4. ISO-228 (BSPP): G1/8, G1/4



La Serie HP6000 está diseñada con un anillo de sujeción especial que proporciona una larga vida útil para los sistemas de lubricación y engrasado para aplicaciones industriales y de transporte. Gracias a su capacidad de fácil conexión y desconexión, a su diseño robusto y compacto y a los materiales utilizados en su construcción, estos racores rápidos son ideales para presiones de hasta 150 bar. La gama está disponible con diferentes roscas (métrica, ISO7 e ISO-228) y es adecuada para el uso con tubos rígidos y semi rígidos para satisfacer diferentes necesidades de aplicación.

- » La Serie HP6000 se utiliza en sistemas de lubricación centralizada:
 - Equipos de fabricación
 - Maquinaria de construcción
 - Automatización industrial
 - Transporte
 - Generación de energía eólica
 - Mantenimiento, reparación y revisión

- » Tubos utilizados:
 - Tubo de poliamida PA 12 HL - PA 12 PHL
 - Manguera de alta presión con cople de unión en su extremo.

DATOS GENERALES

Temperatura	- 30°C ÷ 80°C (ver las características técnicas de los tubos usados)
Presión de funcionamiento	0 ÷ 150 bar con aceite y grasa 0,9 ÷ 60 bar con aire (ver las características técnicas de los tubos usados) 3 ÷ 150 bar para la versión VNR (contacte nuestros ingenieros para gamas de alta presión)
Diámetros	ø 4 - 6 mm
Roscas	M5, M6x0,75, M6x1, M8x1, M10x1, M10x1,5, M12x1, M14x1. ISO7 (BSPT): R1/8, R1/4. ISO-228 (BSPP): G1/8, G1/4
Fluidos	aceite y grasa para lubricación, aire comprimido
Tubo a conectar	aceite y grasa: PA 12 HL - PA 12 PHL Tubo de metal rígido con cople de unión en su extremo (tolerancia de tubos PA según ISO14743) aire comprimido: Poliamida (PA) 6 - 11 - 12, poliuretano (PU), polietileno (PE), poliéster hytrel
Materiales	- modelos estándar: cuerpo y mordaza en latón niquelado, junta tórica en NBR, juntas roscadas en NBR - modelos con VNR: cuerpo y mordaza en latón niquelado, muelle y bola en acero inoxidable, junta tórica en NBR

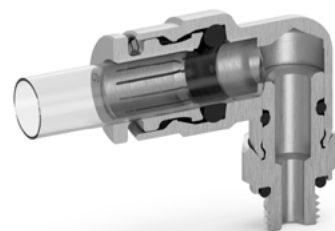

Racores mod. HP6512



Conector macho
Rosca métrica paralela y BSPP ISO-228

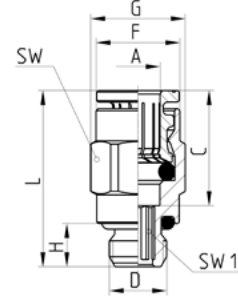

Mod.	A	D	C	F	G	H	L	SW	SW1	Peso (g)
HP6512 4-M5	4	M5x0,8	14	7,8	8,8	4	20	8	2	4
HP6512 4-M6x1	4	M6x1	14	8,8	9,9	4,5	20,5	9	2,5	6
HP6512 4-M8x1	4	M8x1	14	8,8	11,5	6	19	10	2,5	8
HP6512 4-M10x1	4	M10x1	14	8,8	13,5	6	19	12	2,5	10
HP6512 4-M12x1	4	M12x1	14	8,8	15,4	7	20	14	2,5	14
HP6512 4-1/8	4	G1/8	14	8,8	13,5	6	19	12	2,5	10
HP6512 4-1/4	4	G1/4	14	8,8	16,4	7	20,5	15	2,5	14
HP6512 6-M5	6	M5x0,8	16	11,7	13,2	4	22	12	2	8
HP6512 6-M6x1	6	M6x1	16	11,7	13,2	4,5	25	12	2,5	8
HP6512 6-M8x1	6	M8x1	16	11,7	13,2	6	24,5	12	4	8
HP6512 6-M10x1	6	M10x1	16	11,7	13,5	6	21	12	4	10
HP6512 6-M12x1	6	M12x1	16	11,7	15,4	7	22	14	4	13
HP6512 6-1/8	6	G1/8	16	11,7	13,5	6	21	12	4	10
HP6512 6-1/4	6	G1/4	16	11,7	16,4	7	22	15	4	13

Racores mod. HP6510



Conector macho
Rosca métrica cónica y BSPT ISO-7

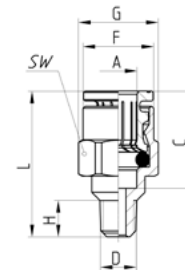

Mod.	A	D	C	F	G	H	L	SW	Peso (g)
HP6510 4-M6x0,75	4	M6x0,75	14	8,8	10,9	6	21	10	6
HP6510 4-M6x1	4	M6x1	14	8,8	10,9	6	21	10	6
HP6510 4-M8x1	4	M8x1	14	8,8	10,9	6	18	10	8
HP6510 4-M10x1	4	M10x1	14	8,8	13,2	6	18	12	10
HP6510 4-1/8	4	R1/8	14	8,8	13,2	7,5	18,5	12	10
HP6510 6-M6x0,75	6	M6x0,75	16	11,7	13,2	6	24	12	8
HP6510 6-M6x1	6	M6x1	16	11,7	13,2	6	24	12	8
HP6510 6-M8x1	6	M8x1	16	11,7	13,2	6	23,5	12	8
HP6510 6-M10x1	6	M10x1	16	11,7	13,2	6	21,5	12	10
HP6510 6-1/8	6	R1/8	16	11,7	13,2	7,5	22	12	10

Racores mod. HPR6512



Conector macho
Rosca métrica paralela

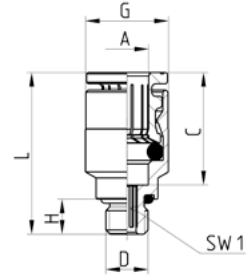

Mod.	A	D	C	G	H	L	SW1	Peso (g)
HPR6512 4-M5	4	M5x0,8	14	8,8	4	20	2	4
HPR6512 4-M6x1	4	M6x1	14	8,8	4,5	20,5	2,5	6
HPR6512 4-M6x0,75	4	M6x0,75	14	8,8	4,5	20,5	2,5	6
HPR6512 6-M5	6	M5x0,8	16	11,7	4	22	2	8
HPR6512 6-M6x1	6	M6x1	16	11,7	4,5	22,5	2,5	8
HPR6512 6-M6x0,75	6	M6x0,75	16	11,7	4,5	22,5	2,5	8

* = con junta
● = con junta tórica

Racores mod. HP6500



Codo macho fijo
Rosca métrica cónica y BSPT ISO-7

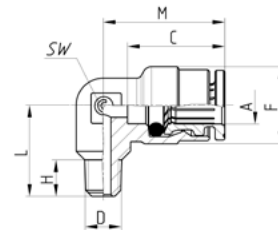

Mod.	A	D	C	F	H	L	M	SW	Peso (g)
HP6500 4-M6x0,75	4	M6x0,75	14	9	6	13,5	17,5	8	6
HP6500 4-M6x1	4	M6x1	14	9	6	13,5	17,5	8	6
HP6500 4-M8x1	4	M8x1	14	9	6	13,5	17,5	8	8
HP6500 4-M10x1	4	M10x1	14	9	6	13,5	17,5	8	10
HP6500 4-M10x1,5	4	M10x1,5	14	9	7,5	15	17,5	8	10
HP6500 4-M12x1	4	M12x1	14	10	7	15	19	10	15
HP6500 4-1/8	4	R1/8	14	9	7,5	15	17,5	8	10
HP6500 4-1/4	4	R1/4	14	10	11,5	19,5	19	10	15
HP6500 6-M6x0,75	6	M6x0,75	16	12,7	6	15	20	9	8
HP6500 6-M6x1	6	M6x1	16	12,7	6	15	20	9	8
HP6500 6-M8x1	6	M8x1	16	12,7	6,5	14	20	9	10
HP6500 6-M10x1	6	M10x1	16	12,7	6	14	20	9	11
HP6500 6-M10x1,5	6	M10x1,5	16	12,7	7	15,5	20	9	11
HP6500 6-M12x1	6	M12x1	16	12,7	7	14,5	20	9	11
HP6500 6-1/8	6	R1/8	16	12,7	7,5	15,5	20	9	11
HP6500 6-1/4	6	R1/4	16	12,7	12	19,5	20	9	11

Racores mod. HP6522

Codo macho giratorio
Rosca métrica paralela y BSPP ISO-228

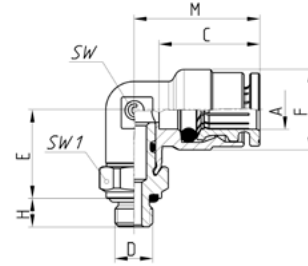

DIMENSIONES										
Mod.	A	D	C	E	F	H	M	SW	SW1	Peso (g)
HP6522 4-M5	4	M5x0,8	14	13	9	4	17,5	8	8	12
HP6522 4-M6	4	M6x1	14	13	9	4,5	17,5	8	9	14
HP6522 4-M6x0,75	4	M6x0,75	14	13	9	4,5	17,5	8	9	14
HP6522 4-M8x1	4	M8x1	14	14,5	9	6	17,5	8	10	15
HP6522 4-M10x1	4	M10x1	14	14,5	9	6	17,5	8	12	23
HP6522 4-1/8	4	G1/8	14	14,5	9	6	17,5	8	12	15
HP6522 4-1/4	4	G1/4	14	15,5	9	7	17,5	8	15	25
HP6522 6-M5	6	M5x0,8	16	13,5	12,7	4	20	9	10	14
HP6522 6-M6	6	M6x1	16	14	12,7	4,5	20	9	10	16
HP6522 6-M6x0,75	6	M6x0,75	16	14	12,7	4,5	20	9	10	16
HP6522 6-M8x1	6	M8x1	16	15	12,7	6	20	9	10	19
HP6522 6-M10x1	6	M10x1	16	15	12,7	6	20	9	12	25
HP6522 6-1/8	6	G1/8	16	15	12,7	6	20	9	12	19
HP6522 6-1/4	6	G1/4	16	15,9	12,7	7	20	9	15	29

Racores mod. HP6520

Codo macho giratorio
Rosca métrica cónica y BSPT ISO-7

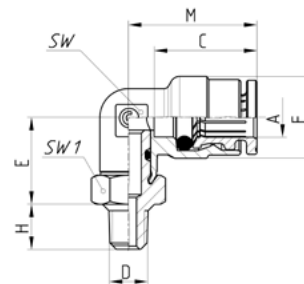

DIMENSIONES										
Mod.	A	D	C	E	F	H	M	SW	SW1	Peso (g)
HP6520 4-M6x1	4	M6x1	14	13	9	6	17,5	8	10	10
HP6520 4-M8x1	4	M8x1	14	14	9	6	17,5	8	10	12
HP6520 4-M10x1	4	M10x1	14	14	9	6	17,5	8	12	15
HP6520 4-M12x1	4	M12x1	14	14	9	6	17,5	8	14	20
HP6520 4-1/8	4	R1/8	14	13	9	7,5	17,5	8	12	15
HP6520 4-1/4	4	R1/4	14	13	9	11	17,5	8	14	25
HP6520 6-M6x1	6	M6x1	16	13,5	12,7	6	20	9	10	14
HP6520 6-M8x1	6	M8x1	16	14,5	12,7	6	20	9	10	17
HP6520 6-M10x1	6	M10x1	16	14,5	12,7	6	20	9	12	21
HP6520 6-M12x1	6	M12x1	16	14,5	12,7	6	20	9	14	23
HP6520 6-1/8	6	R1/8	16	13,5	12,7	7,5	20	9	12	21
HP6520 6-1/4	6	R1/4	16	13,5	12,7	11	20	9	14	28

Racores mod. HP6622



Banjo individual giratorio
Rosca métrica paralela y BSPP ISO-228

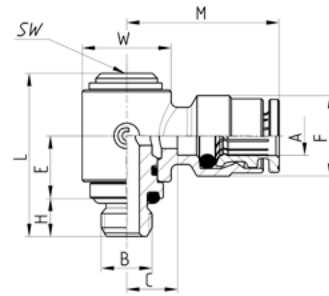

Mod.	A	B	C	E	F	H	L	M	SW	W	Peso (g)
HP6622 6-M6	6,17	M6x1	8	11,5	12,7	4,5	25,8	24	5	13,9	27
HP6622 6-M8x1	6,17	M8x1	8	9,75	12,7	6	25,7	24	5	13,9	29
HP6622 6-1/8	6,17	G1/8	8	9,75	12,7	6	25,7	24	5	13,9	32

Racores mod. HP6580



Conector unión

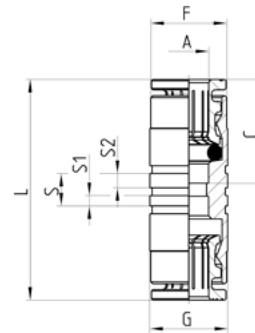

Mod.	A	C	F	G	L	S	S1	S2	Peso (g)
HP6580 4	4	14	8,4	9	29	5	1,6	2,2	14
HP6580 6	6	16	11,7	12	34	5	1,6	2,2	20

Racores mod. HP6590



Pasamuros
Rosca métrica cónica

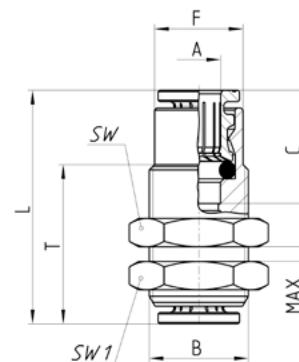

Mod.	A	B	C	F	L	MAX	SW	SW1	T	Peso (g)
HP6590 6	6	M14x1	16	12,5	33	2,12	17	17	22,5	34

Racores mod. HP6550

Conector en codo

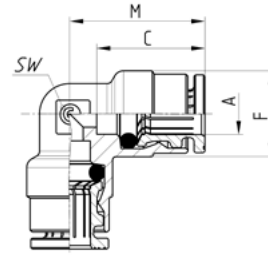

DIMENSIONES						
Mod.	A	C	F	M	SW	Peso (g)
HP6550 4	4	14	9	17,5	8	15
HP6550 6	6	16	12,7	20	9	21

Racores mod. HP6540

Conector en T

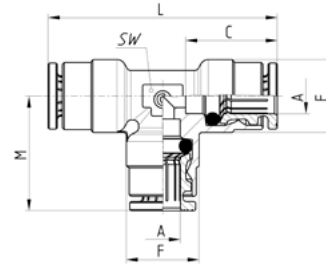

DIMENSIONES							
Mod.	A	C	F	L	M	SW	Peso (g)
HP6540 4	4	14	9	35	17,5	8	20
HP6540 6	6	16	12,7	40	20	9	30

Racores mod. HP6560

Conector en Y

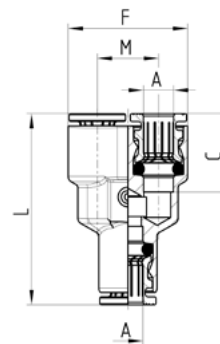

DIMENSIONES						
Mod.	A	C	F	L	M	Peso (g)
HP6560 6	6	16	24,4	39	12,5	34

Racores mod. HP6510 VNR



Conector macho
Rosca métrica cónica y BSPT ISO-7

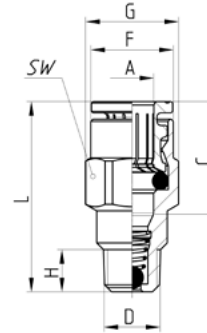

Mod.	A	D	C	F	G	H	L	SW	Peso (g)
HP6510 4-M8x1-VNR	4	M8x1	14	8,8	10,9	6	27,5	10	13,5
HP6510 4-M10x1-VNR	4	M10x1	14	8,8	11	6	27,5	10	17,5
HP6510 4-1/8-VNR	4	R1/8	14	8,8	11	7,5	27,5	10	17,5
HP6510 6-M8x1-VNR	6	M8x1	16	11,7	13,2	6	27	12	14,5
HP6510 6-M10x1-VNR	6	M10x1	16	11,7	13,2	6	27	12	16,5
HP6510 6-1/8-VNR	6	R1/8	16	11,7	13,2	7,5	27	12	16,5

Racores mod. HP6511 VNR



Conector macho
Rosca métrica paralela

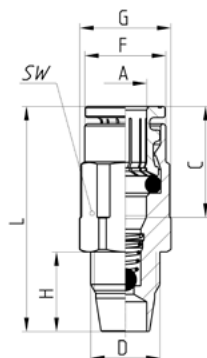

Mod.	A	D	C	F	G	H	L	SW	Peso (g)
HP6511 4-M10x1 VNR	4	M10x1	14	8,8	13,2	11,5	33	12	22
HP6511 6-M10x1 VNR	6	M10x1	16	11,7	13,2	11,5	32,5	12	19

Racores mod. HP6512 VNR



Conector macho
Rosca métrica paralela y BSPP ISO-228

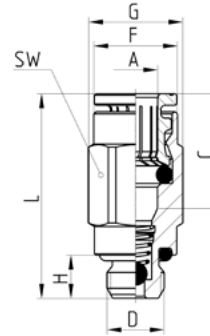

Mod.	A	D	C	F	G	H	L	SW	Peso (g)
HP6512 4-M8x1-VNR	4	M8x1	14	8,8	11,5	6	27,5	10	16
HP6512 4-M10x1-VNR	4	M10x1	14	8,8	11,5	6	27,5	10	18
HP6512 4-1/8-VNR	4	G1/8	14	8,8	11,5	6	27,5	10	18
HP6512 6-M8x1-VNR	6	M8x1	16	11,7	13,2	6	28,5	12	17
HP6512 6-M10x1-VNR	6	M10x1	16	11,7	13,5	6	27	12	21,5
HP6512 6-1/8-VNR	6	G1/8	16	11,7	13,5	6	27	12	21,5

Ranura para tubo metálico realizada con la herramienta de ranurado Camozzi 8TRT (o maquinado)

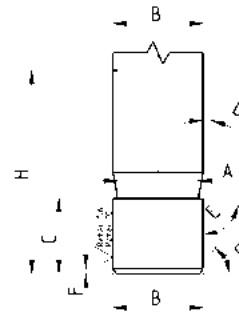

Código	A	B	C	D	E	F	G	H
-	3,4	4	5,3	10°	80°	0,5	45°	16,5
—	5,2	6	6,25	10°	80°	0,5	45°	18

Ranura para tubo metálico realizada por maquinado

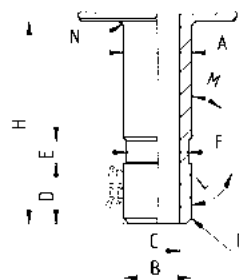

Código	A	B	C	D	E	F	G	H	L	M	N
—	4,1	4	2	5,3	2	3,5	0,5x45°	16,5	75°	45°	0,5
—	6,1	6	4	5,4	2	5,5	0,5x45°	18	75°	45°	0,5

Herramienta para cortar tubos mod. PNZ... y PNZP-12

Corta-tubos mod. PNZ...: las navajas de repuesto se pueden pedir por separado.

Corta-tubos mod. PNZP-12: plástico.



PNZ-...



PNZP-12

Mod.	
PNZ-12	capaz de cortar tubos desde Ø hasta 12 mm
PNZ-25	capaz de cortar tubos desde Ø hasta 25 mm
PNZP-12	capaz de cortar tubos desde Ø hasta 12 mm

Herramienta de ranurado para tubos metálicos

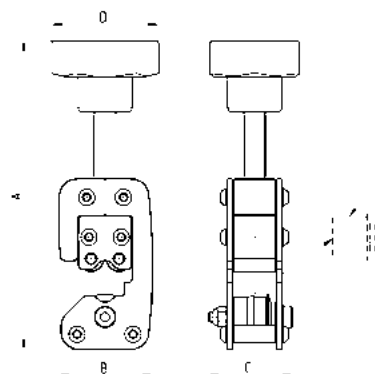

Mod.	Tubo Ø	A (max)	B	C	D	Peso (g)	E (rueda de repuesto)
8TRT 4	4	138	43.5	39	50	450	RTRT 4
8TRT 6	6	140	43.5	39	50	450	RTRT 6